

FP-525

Design Number: FP-525H - Bill Of Material

Ref. No.	Part No.	Description	Quantity
FirstPlay			
1	ZZFP4000	SUPPORT POST	3
2	ZZFP4001	PRETEND PLAY PANEL	1
3	ZZFP4002	CLIMB AND SLIDE PANEL	1
4	ZZFP4004	END CLIMBER	1
5	ZZFP4006	SUPPORT POST FILLER	1
Additional Tool & Maintenance Kits			
6	ZZUN9910	SURFACING WARNING LABEL KIT	1



FP-525

Design Number: FP-525H - Compliance and Technical Data

Reference Document: ASTM F1487-11

Ref. No.	Part No.	Qty.	Description	Unit ASTM Status	Total Weight (lbs)	Pre-Consumer Recycled Content (lbs)	Post-Consumer Content (lbs)	CO2e Footprint (kgs)	Users	Install Hours	Concrete (Yds3)	Active Play Events
1	ZZFP4000	3	SUPPORT POST	N/A	52.08			729	3	1.50	0.00	3
2	ZZFP4001	1	PRETEND PLAY PANEL	N/A	34.08			311	2	0.50	0.00	1
3	ZZFP4002	1	CLIMB AND SLIDE PANEL	N/A	65.02			555	2	0.50	0.00	1
4	ZZFP4004	1	END CLIMBER	N/A	34.61			270	2	0.50	0.00	1
5	ZZFP4006	1	SUPPORT POST FILLER	N/A	4.89			84	0	0.25	0.00	0
6	ZZUN9910	1	SURFACING WARNING LABEL KIT	Certified	0.05			1	0	0.25	0.00	0
Totals:					190.73	0	0	1,949	9	3.50	0.00	6
					85.83 Kg	0 Kg	0 Kg	2 Metric Tons			0.00 m3	



FP-525

Design Number: FP-525H - Compliance and Technical Data

Reference Document: ASTM F1487-11

Ref. No.	Part No.	Qty.	Description	Unit ASTM Status	Total Weight (lbs)	Pre-Consumer Recycled Content (lbs)	Post-Consumer Content (lbs)	CO2e Footprint (kgs)	Users	Install Hours	Concrete (Yds3)	Active Play Events
----------	----------	------	-------------	------------------	--------------------	-------------------------------------	-----------------------------	----------------------	-------	---------------	-----------------	--------------------

ASTM F1487-11

The lay-out for this custom playscape, design number FP-525H, has been configured to meet the requirements of the ASTM F1487-11 standard. In addition, each of the above components listed as "Certified" have been tested and are IPEMA certified. Components listed as "Not Applicable" do not fall within the scope of the ASTM F1487-11 standard and have not been tested. IPEMA certification can be verified on the IPEMA website, www.ipema.org. In the interest of playground safety, IPEMA provides a Third Party Certification Service which validates compliance.

Americans with Disabilities Act Accessibility Guidelines (ADAAG)

The lay-out was also designed to meet the ADAAG published 23-July-2004, by the United States Access Board who installed over a properly maintained surfacing material that is in compliance with ASTM F1951 "Accessibility of Surface Systems Under and Around Playground Equipment" as well as ASTM F1292, "Impact Attenuation of Surfacing Materials Within the Use Zone of Playground Equipment", appropriate for the fall height of the structure.

Installation Times

Installation times are based on one experienced installer. A crew of three experienced individuals can perform the installation within the given time, each member working 1/3 of the given hours. [Eg. Installation Time = 30 hours. For a crew of three, each member will work 10 hours on the installation for a total of 30 hours on the project.]

Carbon Footprint

The CO2e (carbon footprint given in Kilograms and Metric Tons) listed above is a measure of the environmental impact this play structure represents from harvesting raw materials to the time it leaves our shipping dock. Playworld Systems nurtures a total corporate culture that is focused on eliminating carbon producing processes and products, reducing our use of precious raw materials, reusing materials whenever possible and recycling materials at every opportunity. Playworld Systems elected to adopt the Publicly Available Specification; PAS 2050 as published by the British Standards Institute and sponsored by Defra and the Carbon Trust. The PAS 2050 has gained international acceptance as a specification that measures the greenhouse gas emissions in services and goods throughout their entire life cycle.

Pre-Consumer Recycle Content

A measurement, in pounds, that qualifies the amount of material that was captured as waste and diverted from landfill during an initial manufacturing process and is being redirected to a separate manufacturing process to become a different product. E.g. 100% of our Aluminum Tubing is made from captured waste material during the manufacturing process of extruded Aluminum products such as rods, flat bars and H-channels.

Post-Consumer Recycle Content

A measurement, in pounds, that qualifies the amount of material that was once another product that has completed its lifecycle and has been diverted from a landfill as a solid waste through recycling and is now being used in a Playworld Systems' product. E.g. **20% to 40% of the steel in our steel tubing and sheet steel have been diverted from landfills. Automobiles are scrapped and recyclable steel is purchased by the steel mill that produces our raw product.

** The amount of Post-Consumer recycled steel fluctuates daily based on the availability of the recycled steel.



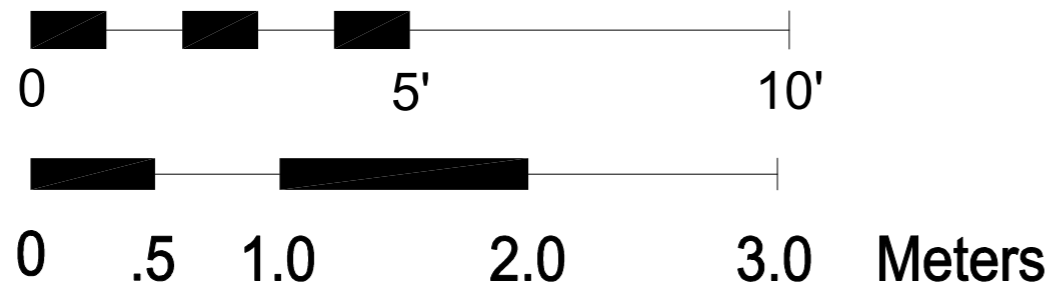
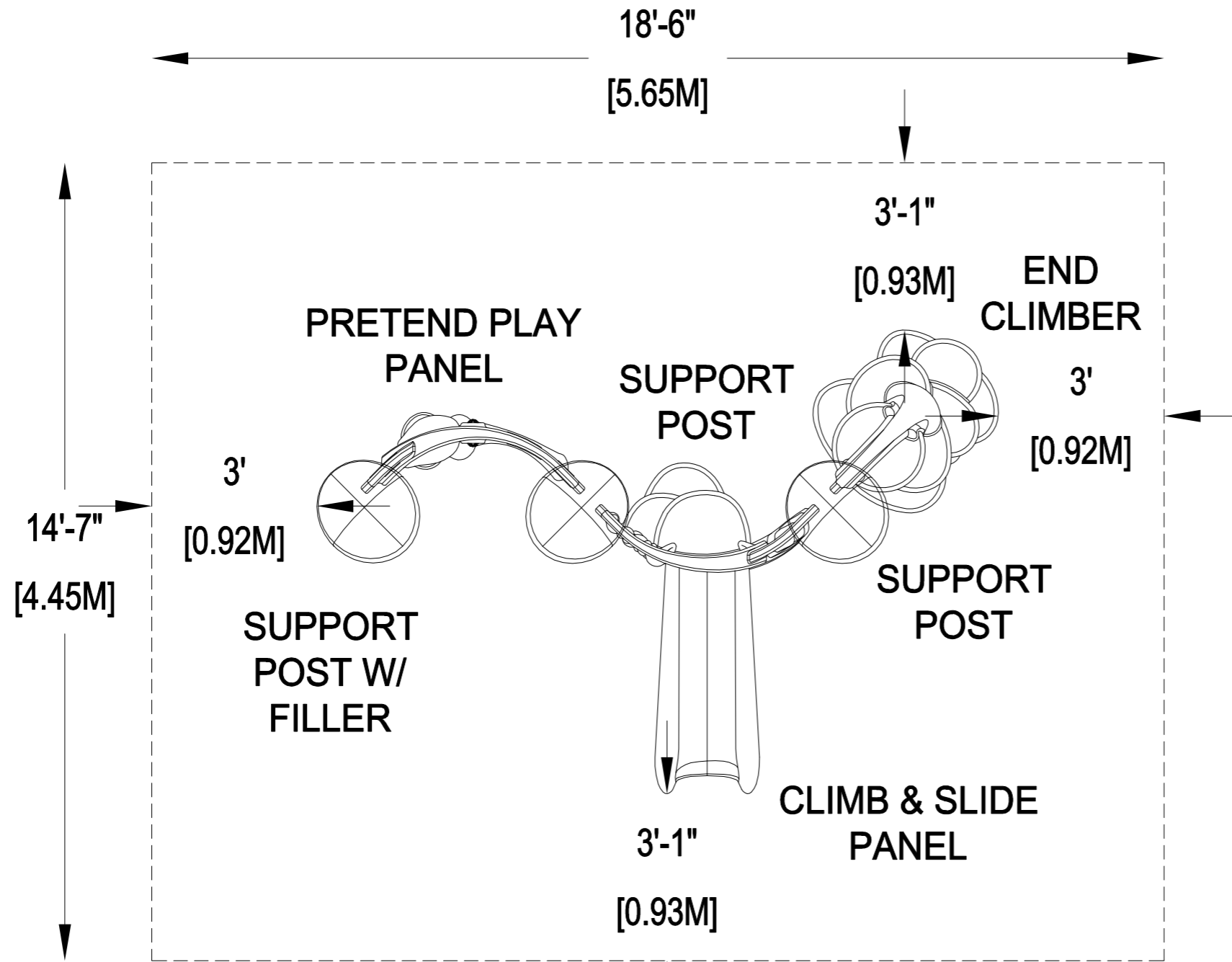

*Playground Supervision Required

PERIMETER: 67' (20,43M)
PER ASTM F2373-08

Playworld Systems, Inc.
1000 Buffalo Road
Lewisburg, PA
17837-9795 USA

PLAYWORLDTM

© 2007 Playworld Systems, Inc.
Playworld is a brand of Playworld Systems, Inc.

- 

9 USERS
- 

6mo-23mo
- 

126" X 87" X 5"
- 

271 Sq.Ft.
- 

186" X 147"
- 

25,18 Sq.M
- 

2 Ft.
- 

.61 M.
- 

PROJECT NO: FP-525	REV: H	DATE: 15-MAR-12
SYSTEM: FIRSTPLAY		SCALE: NOT TO SCALE
SITE PLAN		DRAWN BY: CHIP ZECHMAN

FP-525

CATALOG PRE-DESIGN

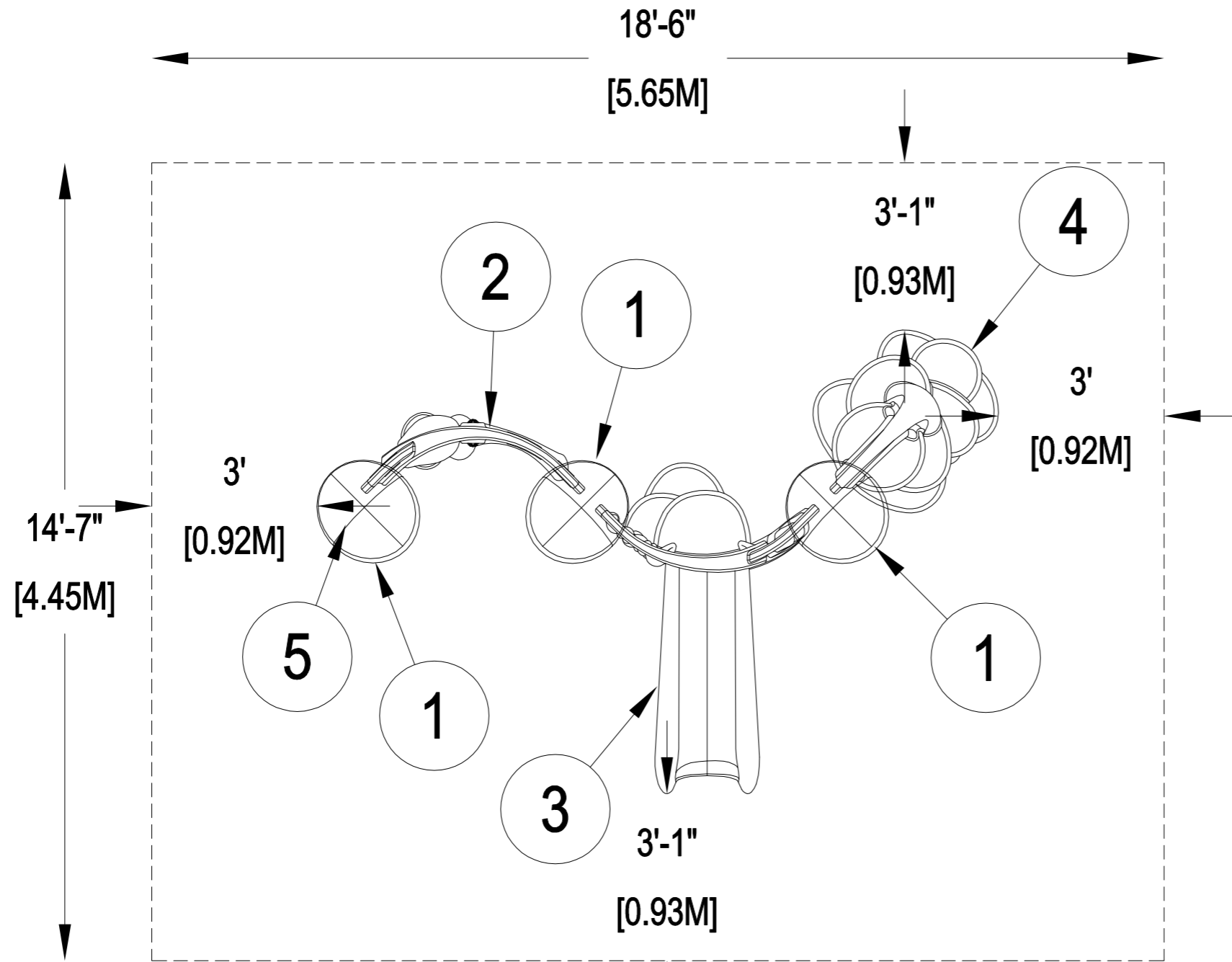

PERIMETER: 67' (20,43M)
PER ASTM F2373-08

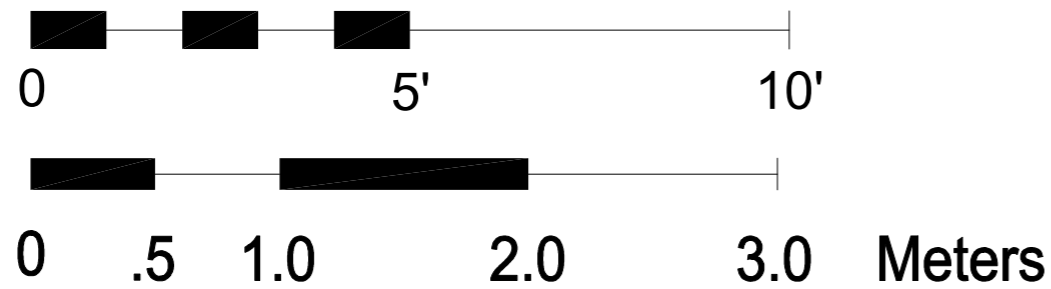







*Playground Supervision Required

Playworld Systems, Inc.
1000 Buffalo Road
Lewisburg, PA
17837-9795 USA

PLAYWORLDTM

© 2007 Playworld Systems, Inc.
Playworld is a brand of Playworld Systems, Inc.

- 
- 
- 
- 
- 
- 
- 

9 USERS
6mo-23mo
126" X 87" X 5"
3,81M X 2,62M X 1,53M

2 FL
.61 M.

271 Sq.Ft.
25,18 Sq.M

186" X 147"
5,65M X 4,45M

PROJECT NO: FP-525	REV: H	DATE: 15-MAR-12
SYSTEM: FIRSTPLAY		SCALE: NOT TO SCALE
SITE PLAN		DRAWN BY: CHIP ZECHMAN

FP-525

CATALOG PRE-DESIGN

FP-525

Catalog Pre-Design



1000 Buffalo Road, Lewisburg, Pa 17837

phone 570.522.9800 - fax 570.522.3030 - 800.233.8404

www.playworldsystems.com

FP-525

Catalog Pre-Design



1000 Buffalo Road, Lewisburg, Pa 17837
 phone 570.522.9800 - fax 570.522.3030 - 800.233.8404
 www.playworldsystems.com

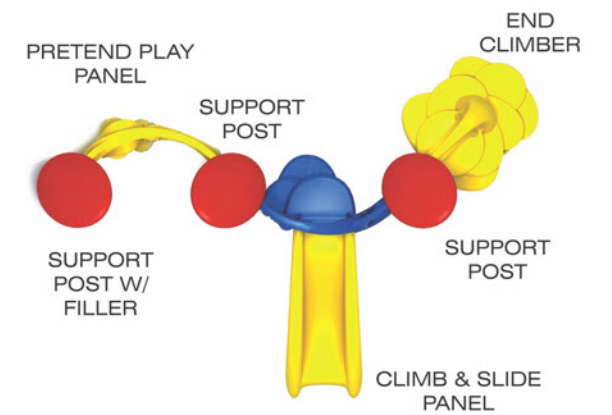

Design Number: FP-525
 FirstPlay™ playscape layout per ASTM F2373-08

Weight:191 lbs (86.64 kg)	Age Group:6-23 Months
Length:12'-07" (3,83 m)	Use Zone L:18'-06" (5,64 m)
Width:8'-07" (2,62 m)	Use Zone W:14'-07" (4,44 m)
Height:5'-00" (1,52 m)	Number of Users:9
Installation Time:4 Hours	Number of Play Events:6

Colors Shown: Primary



FP-525

Catalog Pre-Design



1000 Buffalo Road, Lewisburg, Pa 17837

phone 570.522.9800 - fax 570.522.3030 - 800.233.8404

www.playworldsystems.com